

DRUM INSTRUCTION PROGRAMMING



In This Chapter...

Introduction.....	6-2
Step Transitions	6-4
Overview of Drum Operation	6-8
Drum Control Techniques	6-10
Drum Instruction	6-12

Introduction

Purpose

The Event Drum (EDRUM) instruction in the DL06 CPU electronically simulates an electro-mechanical drum sequencer. The instruction offers enhancements to the basic principle, which we describe first.

Drum Terminology

Drum instructions are best suited for repetitive processes that consist of a finite number of steps. They can do the work of many rungs of ladder logic with elegant simplicity. Therefore, drums can save a lot of programming and debugging time.

We introduce some terminology associated with the **drum** instruction by describing the original mechanical drum shown below. The mechanical drum generally has pegs on its curved surface. The pegs are populated in a particular **pattern**, representing a set of desired actions for machine control. A motor or solenoid rotates the drum a precise amount at specific times. During rotation, stationary wipers sense the presence of pegs (present = on, absent = off). This interaction makes or breaks electrical contact with the wipers, creating electrical **outputs** from the drum. The outputs are wired to devices on a machine for On/Off control.

Drums usually have a finite number of positions within one rotation, called **steps**. Each step represents some process step. At powerup, the drum **resets** to a particular step. The drum rotates from one step to the next based on a **timer**, or on some external **event**. During special conditions, a machine operator can manually increment the drum step using a **jog** control on the drum's drive mechanism. The contact closure of each wiper generates a unique on/off pattern called a **sequence**, designed for controlling a specific machine. Because the drum is circular, it automatically repeats the sequence once per rotation. Applications vary greatly, and a particular drum may rotate once per second, or as slowly as once per week.

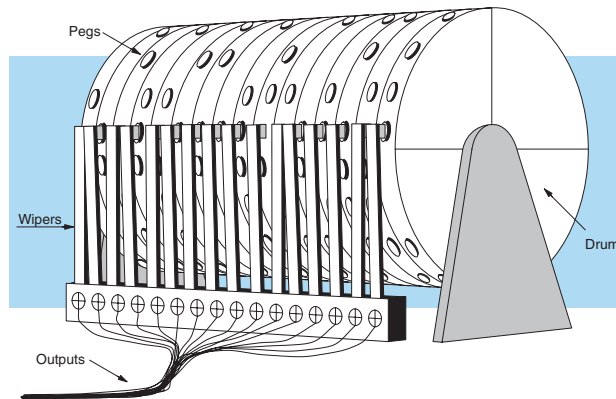

Electronic drums provide the benefits of mechanical drums and more. For example, they have a **preset** feature that is impossible for mechanical drums: The preset function lets you move from the present step *directly* to any other step on command!

Drum Chart Representation

For editing purposes, the electronic drum is presented in chart form in *DirectSOFT* and in this manual. Imagine slicing the surface of a hollow drum cylinder between two rows of pegs, then pressing it flat. Now you can view the drum as a chart as shown below. Each row represents a step, numbered 1 through 16. Each column represents an output, numbered 0 through 15 (to match word bit numbering). The solid circles in the chart represent pegs (On state) in the mechanical drum, and the open circles are empty peg sites (Off state).

STEP	OUTPUTS															
	15	14	13	12	11	10	9	8	7	6	5	4	3	2	1	0
1	○	●	○	●	○	○	●	○	○	○	○	○	○	○	○	○
2	○	○	○	○	○	○	○	○	○	○	○	○	○	○	○	○
3	○	○	○	○	○	○	○	○	○	○	○	○	○	○	○	○
4	●	●	●	●	○	○	○	○	○	○	○	○	○	○	○	○
5	○	○	○	○	○	○	○	○	○	○	○	○	○	○	○	○
6	○	○	○	○	○	○	○	○	○	○	○	○	○	○	○	○
7	●	●	○	○	○	○	○	○	○	○	○	○	○	○	○	○
8	●	○	○	○	○	○	○	○	○	○	○	○	○	○	○	○
9	○	○	○	○	○	○	○	○	○	○	○	○	○	○	○	○
10	○	○	○	○	○	○	○	○	○	○	○	○	○	○	○	○
11	○	○	○	○	○	○	○	○	○	○	○	○	○	○	○	○
12	○	○	○	○	○	○	○	○	○	○	○	○	○	○	○	○
13	○	○	○	○	○	○	○	○	○	○	○	○	○	○	○	○
14	○	○	○	○	○	○	○	○	○	○	○	○	○	○	○	○
15	○	○	○	○	○	○	○	○	○	○	○	○	○	○	○	○
16	○	○	○	○	○	○	○	○	○	○	○	○	○	○	○	○

Output Sequences

The mechanical drum sequencer derives its name from sequences of control changes on its electrical outputs. The following figure shows the sequence of On/Off controls generated by the drum pattern above. Compare the two, and you will find that they are equivalent! If you can see their equivalence, you are well on your way to understanding drum instruction operation.

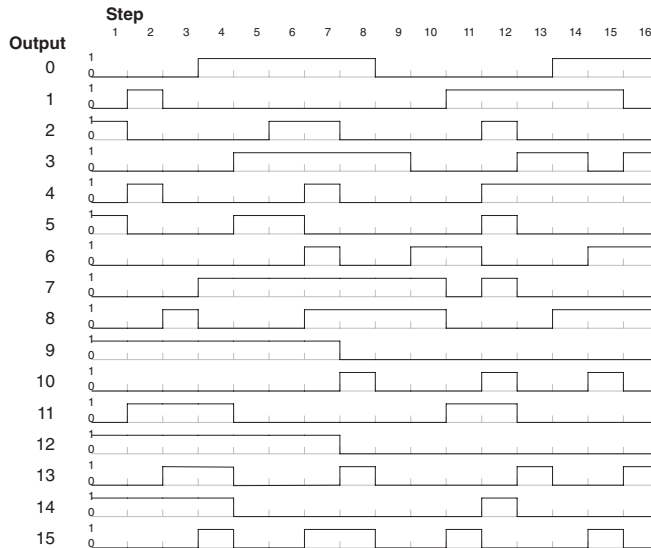

Step Transitions

Drum Instruction Types

There are two types of Drum instructions in the DL06 CPU:

- Timed Drum with Discrete Outputs (DRUM)
- Time and Event Drum with Discrete Outputs (EDRUM)

The two drum instructions include time-based step transitions, and the EDRUM includes event-based transitions as well. Each drum has 16 steps, and each step has 16 outputs. Refer to the figure below. Each output can be either a Y or C coil, offering programming flexibility. We assign Step 1 an arbitrary unique output pattern.

Timer-Only Transitions

Drums move from one step to another based on time and/or an external event (input). Each step has its own transition condition which you assign during the drum instruction. The figure below shows how timer-only transitions work.

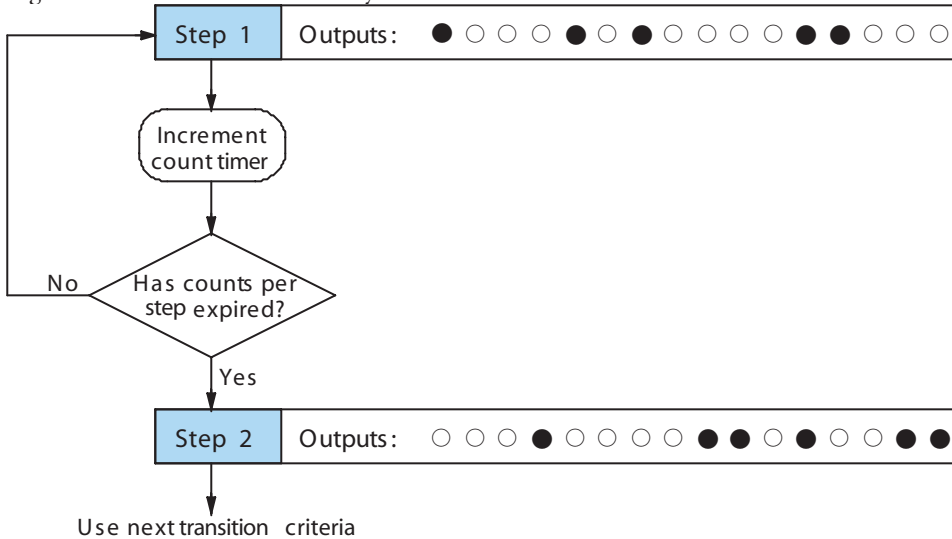

The drum stays in Step 1 for a specific duration (user-programmable). The timebase of the timer is programmable, from 0.01 seconds to 99.99 seconds. This establishes the resolution, or the duration of each “tick of the clock.” Each step uses the same timebase, but has its own unique counts per step, which you program. When the counts for Step 1 have expired, then the drum moves to Step 2. The outputs change immediately to match the new pattern for Step 2.

The drum spends a specific amount of time in each step, given by the formula:

$$\text{Time in step} = 0.01 \text{ seconds} \times \text{Timebase} \times \text{Counts per step}$$

For example, if you program a 5 second time base and 12 counts for Step 1, then the drum will spend 60 seconds in Step 1. The maximum time for any step is given by the formula:

$$\begin{aligned} \text{Max Time per step} &= 0.01 \text{ seconds} \times 9999 \times 9999 \\ &= 999,800 \text{ seconds} = 277.7 \text{ hours} = 11.6 \text{ days} \end{aligned}$$



NOTE: When first choosing the timebase resolution, a good rule of thumb is to make it about 1/10 the duration of the shortest step in your drum. Then you will be able to optimize the duration of that step in 10% increments. Other steps with longer durations allow optimizing by even smaller increments (percentage-wise). Also, note that the drum instruction executes once per CPU scan. Therefore, it is pointless to specify a drum timebase that is much faster than the CPU scan time.

Timer and Event Transitions

Step transitions may also occur based on time and/or external events. The figure below shows how step transitions work in these cases.

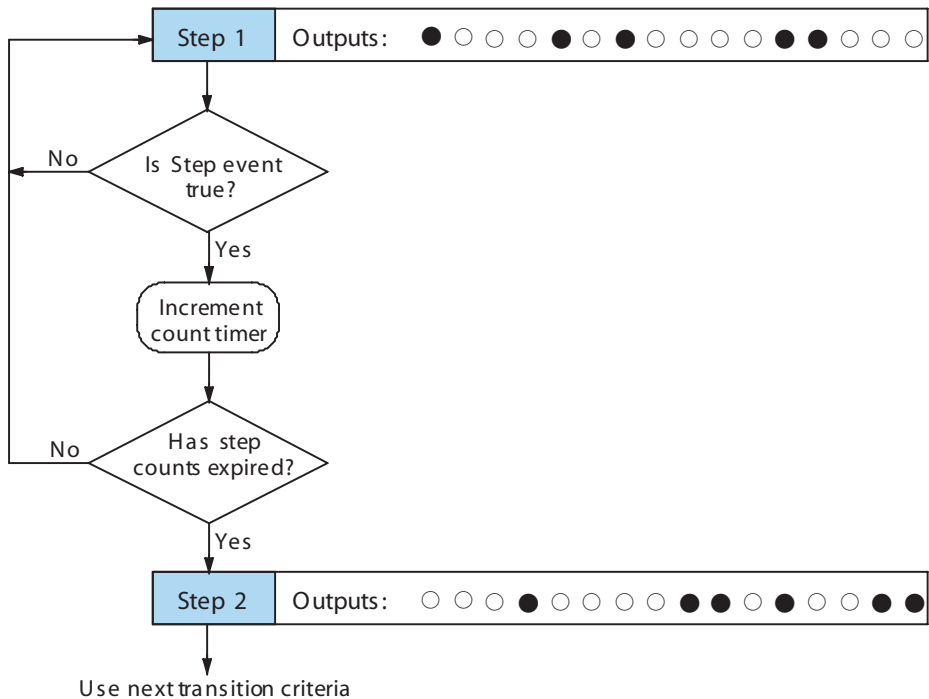

When the drum enters Step 1, it sets the output pattern as shown. Then it begins polling the external input programmed for that step. You can define event inputs as X, Y, or C discrete point types. Suppose we select X0 for the Step 1 event input. If X0 is off, then the drum remains in Step 1. When X0 is On, the event criteria is met and the timer increments. The timer increments as long as the event (X0) remains true. When the counts for Step 1 have expired, then the drum moves to Step 2. The outputs change immediately to match the new pattern for Step 2.

Event-Only Transitions

Step transitions do not require both the event and the timer criteria programmed for each step. You have the option of programming just one of the two, and even mixing transition types among all the steps of the drum. For example, you might want Step 1 to transition on an event, Step 2 to transition on time only, and Step 3 to transition on both time and an event. Furthermore, you may elect to use only part of the 16 steps, and only part of the 16 outputs.

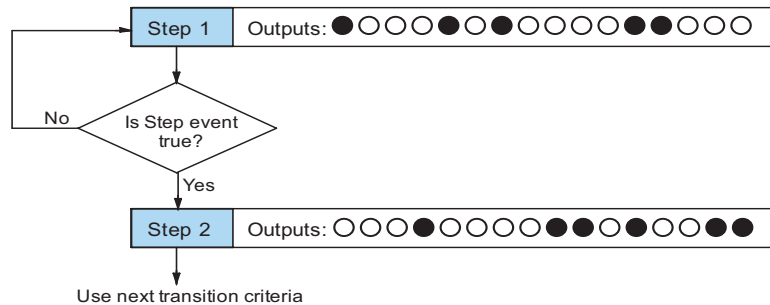

Counter Assignments

Each drum instruction uses the resources of four counters in the CPU. When programming the drum instruction, you select the first counter number. The drum also uses the next three counters automatically. The counter bit associated with the first counter turns on when the drum has completed its cycle, going off when the drum is reset. These counter values and the counter bit precisely indicate the progress of the drum instruction, and can be monitored by your ladder program.

Suppose we program a timer drum to have 8 steps, and we select CT10 for the counter number (remember, counter numbering is in octal). Counter usage is shown to the right. The right column holds typical values, interpreted below.

Counter Assignments			
CT10	Counts in step	V1010	1528
CT11	Timer Value	V1011	0200
CT12	Preset Step	V1012	0001
CT13	Current Step	V1013	0004

CT10 shows that we are at the 1528th count in the current step, which is step 4 (shown in CT13). If we have programmed step 4 to have 3000 counts, then the step is just over half completed. CT11 is the count timer, shown in units of 0.01 seconds. So, each least-significant-digit change represents 0.01 seconds. The value of 200 means that we have been in the current count (1528) for 2 seconds (0.01 x 200). Finally, CT12 holds the preset step value which was programmed into the drum instruction. When the drum's Reset input is active, it presets to step 1 in this case. The value of CT12 changes only if the ladder program writes to it, or the drum instruction is edited and the program is restarted. Counter bit CT10 turns on when the drum cycle is complete, and turns off when the drum is reset.

Last Step Completion

The last step in a drum sequence may be any step number, since partial drums are valid. Refer to the following figure. When the transition conditions of the last step are met, the drum sets the counter bit corresponding to the counter named in the **drum instruction** box (such as CT10). Then it moves to a final “**drum complete**” state. The drum outputs remain in the pattern defined for the last step. Having finished a drum cycle, the Start and Jog inputs have no effect at this point. The drum leaves the “**drum complete**” state when the Reset input becomes active (or on a program-to-run mode transition). It resets the **drum complete** bit (such as CT10), and then goes directly to the appropriate step number defined as the preset step.

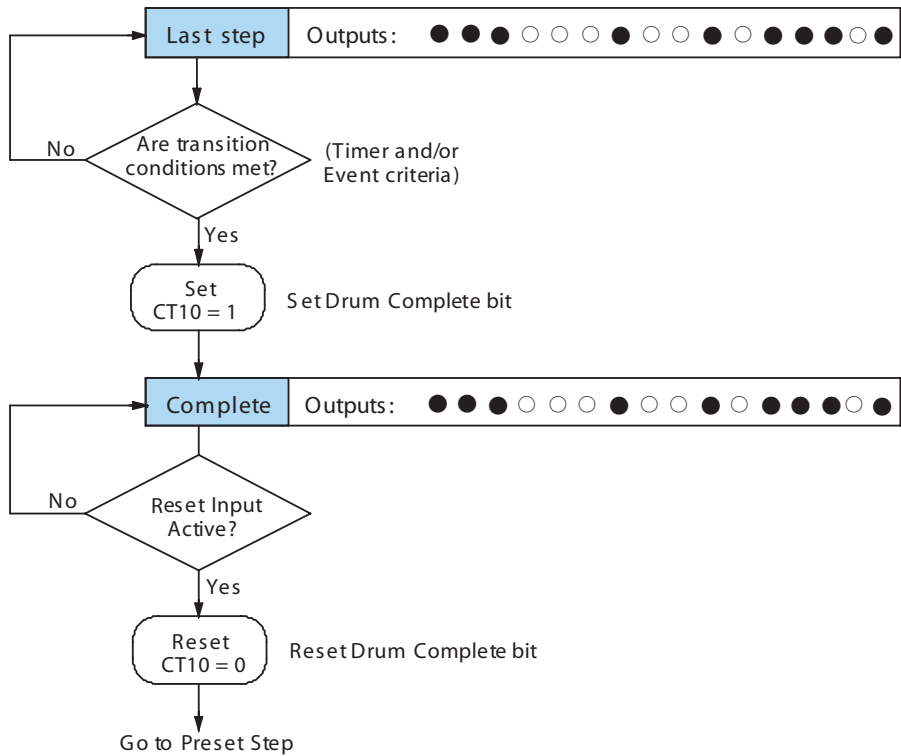

Overview of Drum Operation

Drum Instruction Block Diagram

The **drum instruction** utilizes various inputs and outputs in addition to the drum pattern itself. Refer to the figure below.

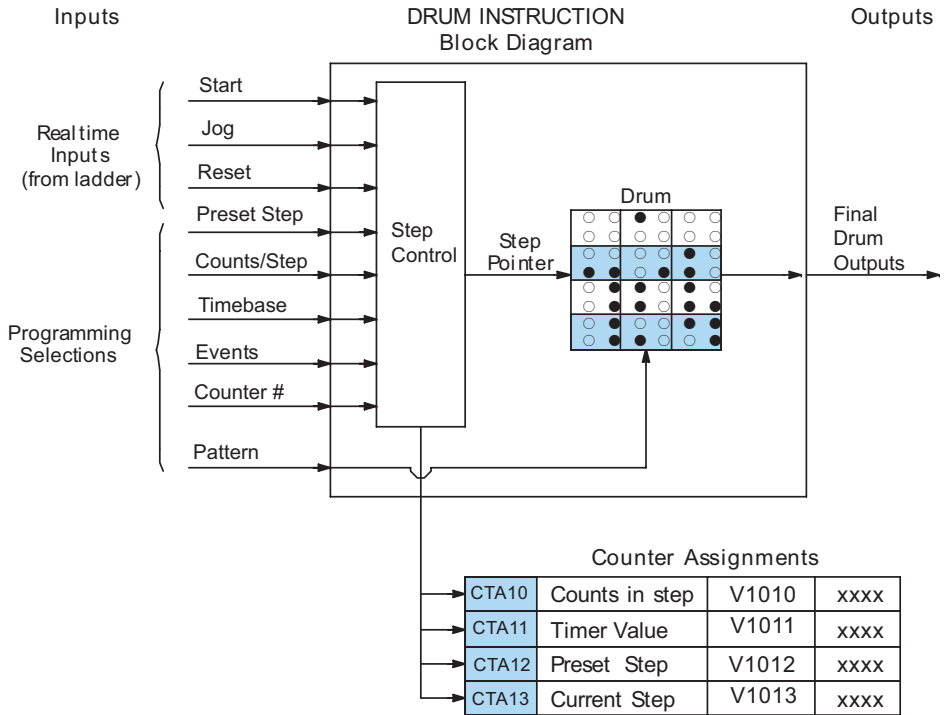

The **drum instruction** accepts several inputs for step control, the main control of the drum. The inputs and their functions are:

- **Start** – The Start input is effective only when Reset is off. When Start is on, the drum timer runs if it is in a timed transition, and the drum looks for the input event during event transitions. When Start is off, the drum freezes in its current state (Reset must remain off), and the drum outputs maintain their current on/off pattern.
- **Jog** – The jog input is only effective when Reset is off (Start may be either on or off). The jog input increments the drum to the next step on each off-to-on transition (only EDRUM supports the jog input).
- **Reset** – The Reset input has priority over the Start input. When Reset is on, the drum moves to its preset step. When Reset is off, then the Start input operates normally.
- **Preset Step** – A step number from 1 to 16 that you define (typically is step 1). The drum moves to this step whenever Reset is on, and whenever the CPU first enters run mode.

- **Counts/Step** – The number of timer counts the drum spends in each step. Each step has its own counts parameter. However, programming the counts/step is optional.
- **Timer Value** – the current value of the counts/step timer.
- **Counter #** – The counter number specifies the first of four consecutive counters which the drum uses for step control. You can monitor these to determine the drum's progress through its control cycle. The DL06 has 128 counters (CT0 – CT177 in octal).
- **Events** – Either an X, Y, C, S, T, or CT type discrete point serves as step transition inputs. Each step has its own event. However, programming the event is optional.



WARNING: The outputs of a drum are enabled any time the CPU is in Run Mode. The Start Input does not have to be on, and the Reset input does not disable the outputs. Upon entering Run Mode, drum outputs automatically turn on or off according to the pattern of the current step of the drum. This initial step number depends on the counter memory configuration: non-retentive versus retentive.

Powerup State of Drum Registers

The choice of the starting step on powerup and program-to-run mode transitions are important to consider for your application. Please refer to the following chart. If the counter memory is configured as non-retentive, the drum is initialized the same way on every powerup or program-to-run mode transition. However, if the counter memory is configured to be retentive, the drum will stay in its previous state.

Counter Number	Function	Initialization on Powerup	
		Non-Retentive Case	Retentive Case
CTA(n)	Current Step Count	Initialize = 0	Use Previous (no change)
CTA(n + 1)	Counter Timer Value	Initialize = 0	Use Previous (no change)
CTA(n + 2)	Preset Step	Initialize = Preset Step #	Use Previous (no change)
CTA(n + 3)	Current Step #	Initialize = Preset Step #	Use Previous (no change)

Applications with relatively fast drum cycle times typically will need to be reset on powerup, using the non-retentive option. Applications with relatively long drum cycle times may need to resume at the previous point where operations stopped, using the retentive case. The default option is the retentive case. This means that if you initialize scratchpad V-memory, the memory will be retentive.

In the figure below, we focus on how the Jog input works on event drums. To the left of the diagram, note that the off-to-on transitions of the Jog input increments the step. Start may be either on or off (however, Reset must be off). Two jogs takes the drum to step three. Next, the Start input turns on, and the drum begins running normally. During step 6 another Jog input signal occurs. This increments the drum to step 7, setting the timer to 0. The drum begins running immediately in step 7, because Start is already on. The drum advances to step 8 normally.

As the drum enters step 14, the Start input turns off. Two more Jog signals moves the drum to step 16. However, note that a third Jog signal is required to move the drum through step 16 to “**drum complete**”. Finally, a **Reset** input signal arrives which forces the drum into the preset step and turns off the drum complete bit.

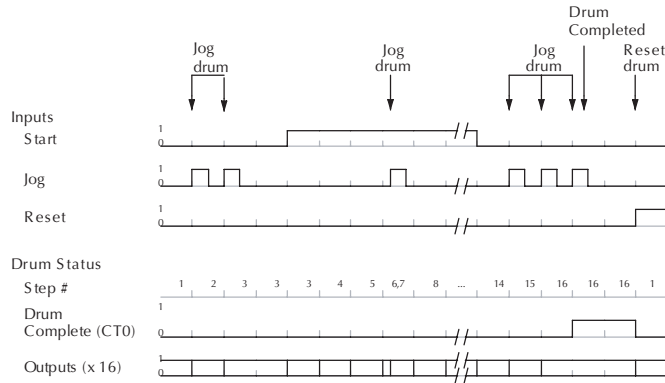

Self-Resetting Drum

Applications often require drums that automatically start over once they complete a cycle. This is easily accomplished, using the drum complete bit. In the figure to the right, the drum instruction setup is for CT10, so we logically OR the drum complete bit (CT10) with the Reset input. When the last step is done, the drum turns on CT10 which resets itself to the preset step, also resetting CT10. Contact X2 still works as a manual reset.

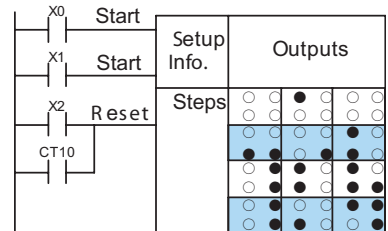

Initializing Drum Outputs

The outputs of a drum are enabled any time the CPU is in run mode. On program-to-run mode transitions, the drum goes to the preset step, and the outputs energize according to the pattern of that step. If your application requires all outputs to be off at powerup, make the preset step in the drum a “**reset step**”, with all outputs off.

Using Complex Event Step Transitions

Each event-based transition accepts only one contact reference for the event. However, this does not limit events to just one contact. Just use a control relay contact such as C0 for the step transition event. Elsewhere in ladder logic, you may use C0 as an output coil, making it dependent on many other events (contacts).

Drum Instruction

The DL06 drum instructions may be programmed using *DirectSOFT*, or for the EDRUM instruction only you can use a handheld programmer (firmware version v2.21 or later). This section covers entry using *DirectSOFT* for all instructions plus the handheld mnemonics for the EDRUM instruction.

Timed Drum with Discrete Outputs (DRUM)

The Timed Drum with Discrete Outputs is the most basic of the DL06’s drum instructions. It operates according to the principles covered on the previous pages. Below is the instruction in chart form as displayed by *DirectSOFT*.

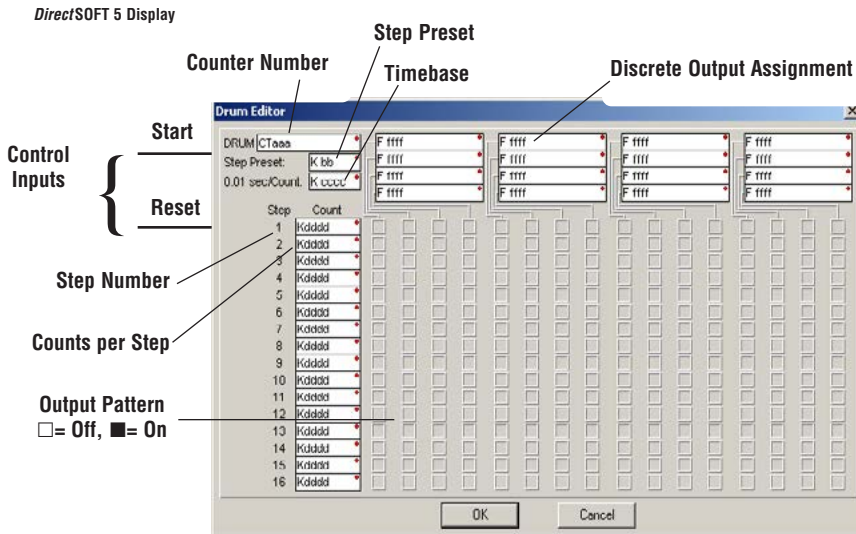

The Timed Drum features 16 steps and 16 outputs. Step transitions occur only on a timed basis, specified in counts per step. Unused steps must be programmed with “counts per step”=0 (this is the default entry). The discrete output points may be individually assigned as X, Y, or C types, or may be left unused. The output pattern may be edited graphically with *DirectSOFT*.

Whenever the Start input is energized, the drum’s timer is enabled. It stops when the last step is complete, or when the Reset input is energized. The drum enters the preset step chosen upon a CPU program-to-run mode transition, and whenever the Reset input is energized.

Drum Parameters	Field	Data Types	Ranges
Counter Number	aaa --	0 --174	
Preset Step	bb	K	1 -- 16
Timer base	cccc	K	0 -- 99.99 seconds
Counts per step	dddd	K	0 -- 9999
Discrete Outputs	Ffff	X, Y, C	see memory map

Drum instructions use four counters in the CPU. The ladder program can read the counter values for the drum's status. The ladder program may write a new preset step number to CTA(n+2) at any time. However, the other counters are for monitoring purposes only.

Counter Number	Ranges of (n)	Function	Counter Bit Function
CTA(n)	0 -- 174	Counts in step	CT(n) = Drum Complete
CTA(n+1)	1 -- 175	Timer value	CT(n+1) = (not used)
CTA(n+2)	2 -- 176	Preset Step	CT(n+2) = (not used)
CTA(n+3)	3 -- 177	Current Step	CT(n+3) = (not used)

The following ladder program shows the DRUM instruction in a typical ladder program, as shown by *DirectSOFT*. Steps 1 through 10 are used, and twelve of the sixteen output points are used. The preset step is step 1. The timebase runs at $(K10 \times 0.01) = 0.1$ second per count. Therefore, the duration of step 1 is $(25 \times 0.1) = 2.5$ seconds. In the last rung, the Drum Complete bit (CT10) turns on output Y0 upon completion of the last step (step 10). A drum reset also resets CT10.

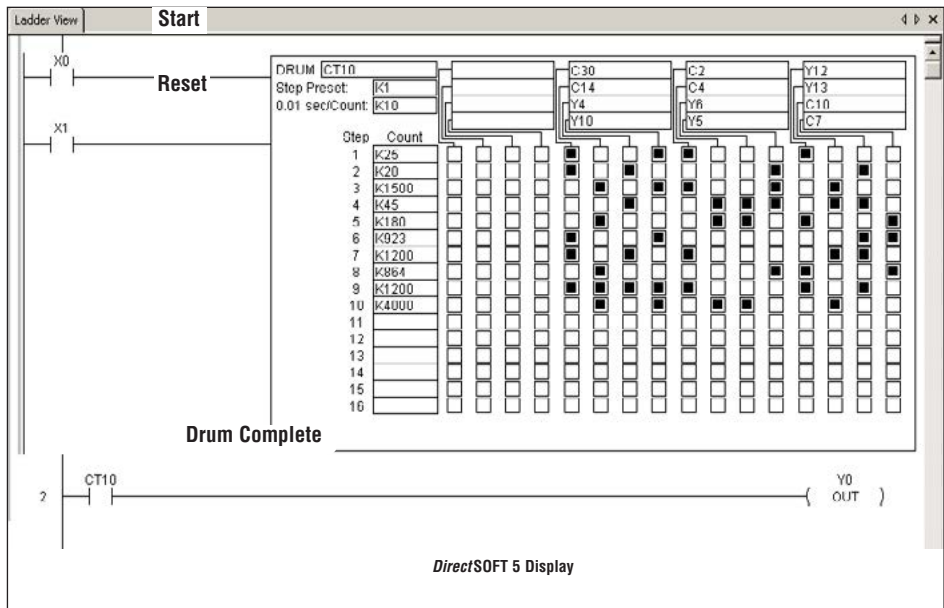

Event Drum (EDRUM)

The Event Drum (EDRUM) features time-based and event-based step transitions. It operates according to the general principles of drum operation covered in the beginning of this chapter. Below is the instruction as displayed by *DirectSOFT*.

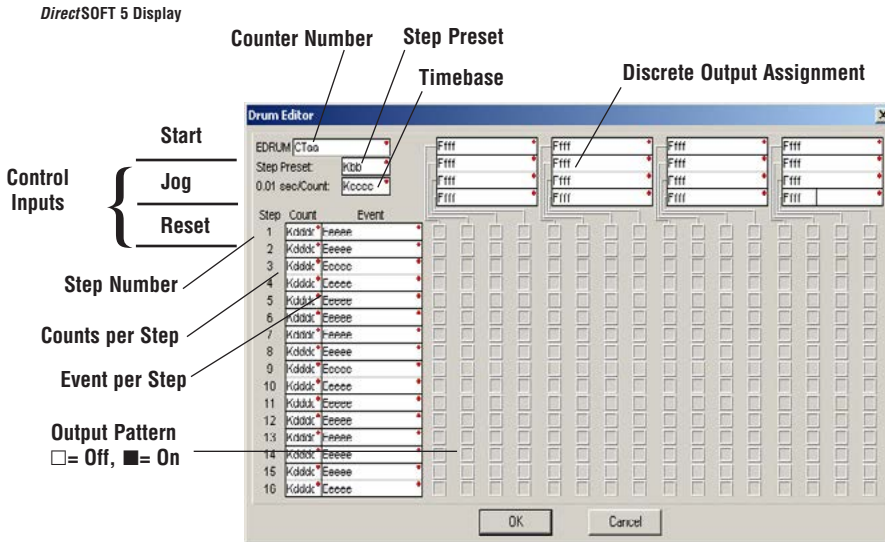

The Event Drum features 16 steps and 16 discrete outputs. Step transitions occur on timed and/or event basis. The jog input also advances the step on each off-to-on transition. Time is specified in counts per step, and events are specified as discrete contacts. Unused steps and events must be left blank. The discrete output points may be individually assigned.

Drum Parameters	Field	Data Types	Ranges
Counter Number	aa	--	0 -- 174
Preset Step	bb	K	1 -- 16
Timer base	cccc	K	0 -- 99.99 seconds
Counts per step	dddd	K	0 -- 9999
Event	Eeeee	X, Y, C, S, T, CT, SP	see memory map
Discrete Outputs	ffff	X, Y, C	see memory map

Whenever the Start input is energized, the drum's timer is enabled. As long as the event is true for the current step, the timer runs during that step. When the step count equals the counts per step, the drum transitions to the next step. This process stops when the last step is complete, or when the Reset input is energized. The drum enters the preset step chosen upon a CPU program-to-run mode transition, and whenever the Reset input is energized.

Drum instructions use four counters in the CPU. The ladder program can read the counter values for the drum's status. The ladder program may write a new preset step number to CTA(n+2) at any time. However, the other counters are for monitoring purposes only.

Counter Number	Ranges of (n)	Function	Counter Bit Function
CTA(n)	0 -- 174	Counts in step	CT(n) = Drum Complete
CTA(n+1)	1 -- 175	Timer value	CT(n+1) = (not used)
CTA(n+2)	2 -- 176	Preset Step	CT(n+2) = (not used)
CTA(n+3)	3 -- 177	Current Step	CT(n+3) = (not used)

The following ladder program shows the EDRUM instruction in a typical ladder program, as shown by *DirectSOFT*. Steps 1 through 11 are used, and all sixteen output points are used. The preset step is step 1. The timebase runs at $(K10 \times 0.01) = 0.1$ second per count. Therefore, the duration of step 1 is $(1 \times 0.1) = 0.1$ second. Note that step 1 is time-based only (event is left blank). And, the output pattern for step 1 programs all outputs off, which is a typically desirable powerup condition. In the last rung, the Drum Complete bit (CT4) turns on output Y0 upon completion of the last step (step 11). A drum reset also resets CT4.

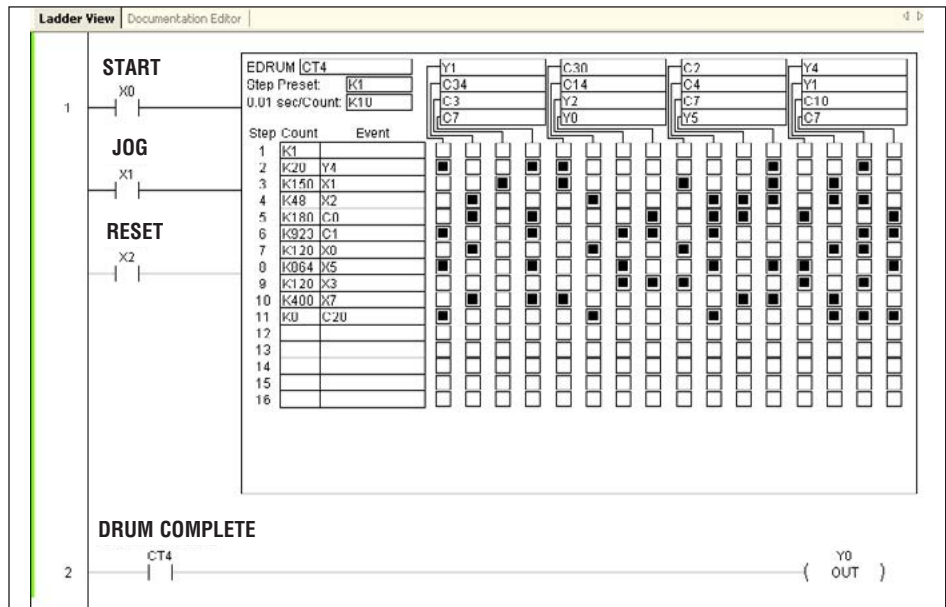

Handheld Programmer Drum Mnemonics

The EDRUM instruction can also be programmed using a handheld programmer. This section explains entry via the handheld programmer.

First, enter Store instructions for the ladder rung controlling the drum's ladder inputs. In the example to the right, the timer drum's Start, Jog, and Reset inputs are controlled by X0, X1 and X2 respectively. The required keystrokes are listed beside the mnemonic.

These keystrokes precede the EDRUM instruction mnemonic. Note that the ladder rungs for Start, Jog and Reset inputs are not limited to being single-contact rungs.

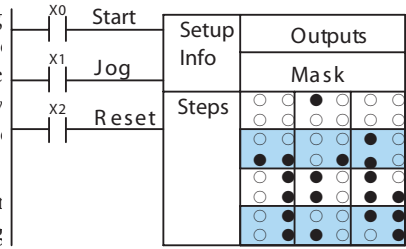

(Repeat for Store X1 and Store X2)

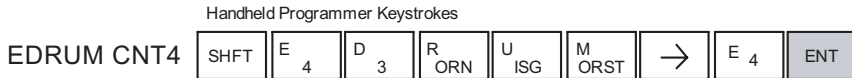

After the Store instructions, enter the EDRUM (using Counter CT0) as shown:

After entering the EDRUM mnemonic as above, the handheld programmer creates an input form for all the drum parameters. The input form consists of approximately fifty or more default mnemonic entries containing DEF (define) statements. The default mnemonics are already input for you, so they appear automatically. Use the NXT and PREV keys to move forward and backward through the form. Only the editing of default values is required, thus eliminating many keystrokes. The entries required for the basic timer drum are in the chart below.



NOTE: Default entries for output points and events are "DEF 0000", which means they are unassigned. If you need to go back and change an assigned output as unused again, enter "K0000". The entry will again show as "DEF 0000".

Drum Parameters	Multiple Entries	Mnemonic / Entry	Default Mnemonic	Valid Data Types	Ranges
Start Input	--	STR (plus input rung)	--	--	--
Jog Input	--	STR (plus input rung)	--	--	--
Reset Input	--	STR (plus input rung)	--	--	--
Drum Mnemonic	--	DRUM CNT aa	--	CT	0 -- 174
Preset Step	1	bb	DEF K0000	K	1 -- 16
Timer base	1	cccc	DEF K0000	K	1 -- 9999
Output points	16	fff	DEF 0000	X, Y, C	see memory map
Counts per step	16	dddd	DEF K0000	K	0 -- 9999
Events	16	dddd	DEF K0000	X, Y, C, S, T, CT, SP	see memory map
Output pattern	16	gggg	DEF K0000	K	0 -- FFFF

Using the DRUM entry chart (two pages before), we show the method of entry for the basic time/event drum instruction. First, we convert the output pattern for each step to the equivalent hex number, as shown in the following example.

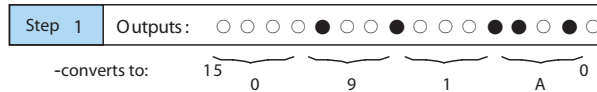

The following diagram shows the method for entering the previous EDRUM example on the HHP. The default entries of the form are in parenthesis. After the drum instruction entry (on the fourth row), the remaining keystrokes over-write the numeric portion of each default DEF statement. **NOTE:** Drum editing requires Handheld Programmer firmware version 2.21 or later.



NOTE: You may use the *NXT* and *PREV* keys to skip past entries for unused outputs or steps.

Handheld Programmer Keystrokes

Start	\$ STR	→	A 0	ENT					
Jog	\$ STR	→	B 1	ENT					
Reset	\$ STR	→	C 2	ENT					
Drum Inst.	SHFT	E 4	D 3	R ORN	U ISG	M ORST	→	E 4	ENT
Preset Step	(DEF K0001)	NEXT							
Time Base	(DEF K0000)	G 6	E 4	NEXT					
Outputs	{	(DEF 0000)	SHFT	C 2	H 7	NEXT			
		(DEF 0000)	SHFT	C 2	B 1	A 0	NEXT		
		(DEF 0000)	SHFT	Y MLS	B 1	NEXT			
		(DEF 0000)	SHFT	Y MLS	E 4	NEXT			
		(DEF 0000)	SHFT	Y MLS	F 5	NEXT			
		(DEF 0000)	SHFT	Y MLS	G 6	NEXT			
		(DEF 0000)	SHFT	C 2	E 4	NEXT			
		(DEF 0000)	SHFT	C 2	C 2	NEXT			
		(DEF 0000)	SHFT	Y MLS	A 0	NEXT			
		(DEF 0000)	SHFT	Y MLS	C 2	NEXT			
		(DEF 0000)	SHFT	C 2	B 1	E 4	NEXT		
		(DEF 0000)	SHFT	C 2	D 3	A 0	NEXT		
		(DEF 0000)	SHFT	Y MLS	G 6	NEXT			
		(DEF 0000)	SHFT	Y MLS	H 7	NEXT			
		(DEF 0000)	SHFT	C 2	D 3	E 4	NEXT		
		16	(DEF 0000)	SHFT	Y MLS	B 1	NEXT		

Note: You may use the *NXT* and *PREV* keys to skip past entries for unused outputs or steps.

Handheld Programmer Keystrokes cont'd

Counts/Step	{	(DEF K0000)	F 5	NEXT						
		(DEF K0000)	C 2	A 0	NEXT					
		(DEF K0000)	B 1	F 5	A 0	NEXT				
		(DEF K0000)	E 4	F 5	NEXT					
		(DEF K0000)	B 1	I 8	A 0	NEXT				
		(DEF K0000)	J 9	C 2	D 3	NEXT				
		(DEF K0000)	B 1	C 2	A 0	NEXT				
		(DEF K0000)	I 8	G 6	E 4	NEXT				
		(DEF K0000)	B 1	C 2	A 0	A 0	NEXT			
		(DEF K0000)	E 4	A 0	A 0	NEXT				
		(DEF K0000)	NEXT							
		(DEF K0000)	NEXT							
		(DEF K0000)	NEXT							
		(DEF K0000)	NEXT							
		(DEF K0000)	NEXT							
		16	(DEF K0000)	NEXT						

← skip over unused steps

(Continued on next page)

Handheld Programmer Keystrokes cont'd

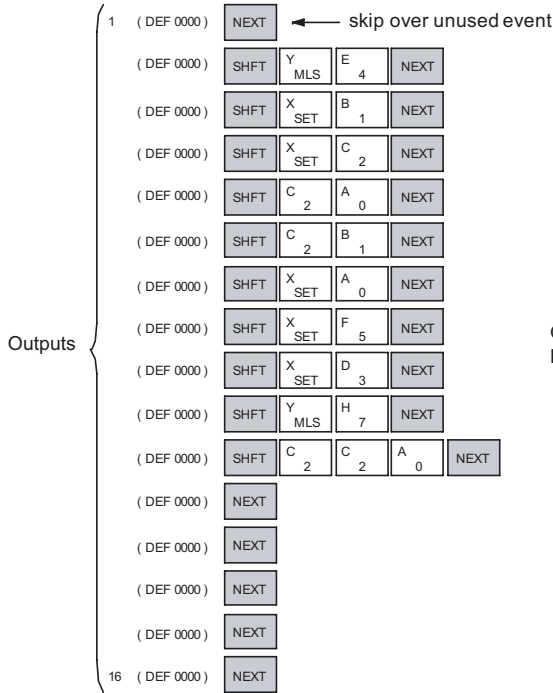

Handheld Programmer Keystrokes cont'd

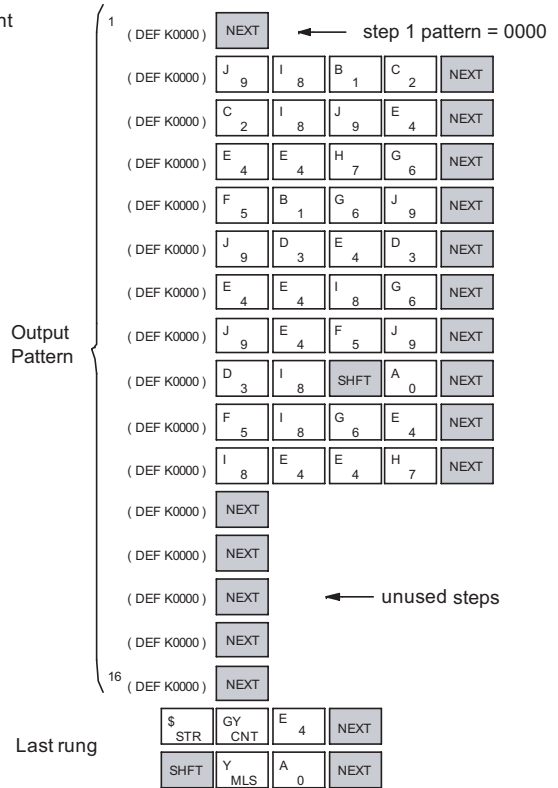

NOTE: You may use the **NXT** and **PREV** keys to skip past entries for unused outputs or steps.

NOTE: For ease of operation when using the **EDRUM** instruction, we recommend using **DirectSOFT** over the handheld programmer.

Masked Event Drum with Discrete Outputs (MDRMD)

The Masked Event Drum with Discrete Outputs has all the features of the basic Event Drum plus final output control for each step. It operates according to the general principles of drum operation covered in the beginning of this section. Below is the instruction in chart form as displayed by *DirectSOFT*.

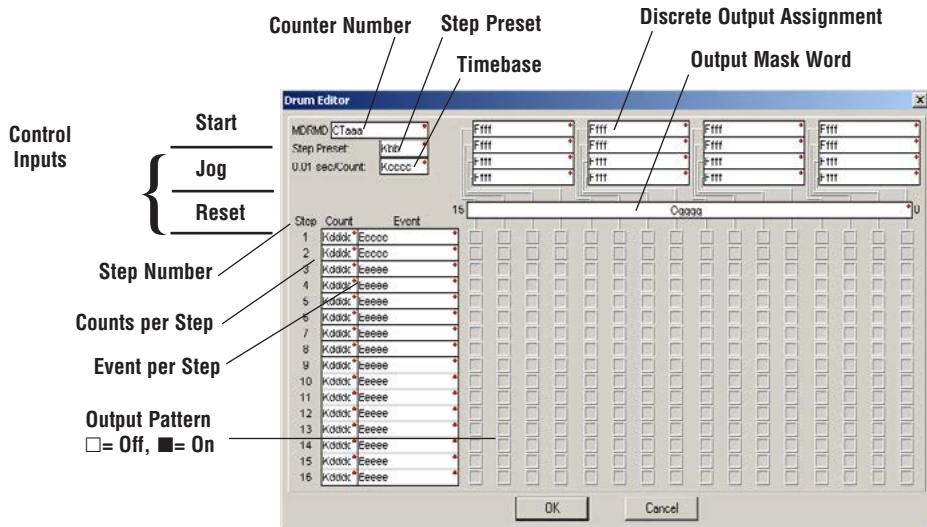

The Masked Event Drum with Discrete Outputs features sixteen steps and sixteen outputs. Drum outputs are logically ANDed bit-by-bit with an output mask word for each step. The Ggggg field specifies the beginning location of the 16 mask words. Step transitions occur on timed and/or event basis. The jog input also advances the step on each off-to-on transition. Time is specified in counts per step, and events are specified as discrete contacts. Unused steps and events can be left blank (this is the default entry). Whenever the Start input is energized, the drum's timer is enabled. As long as the event is true for the current step, the timer runs during that step. When the step count equals the counts per step, the drum transitions to the next step. This process stops when the last step is complete, or when the Reset input is energized. The drum enters the preset step chosen upon a CPU program-to-run mode transition, and whenever the Reset input is energized.

Drum Parameters	Field	Data Types	Ranges
Counter Number	aaa	-	0 – 174
Preset Step	bb	K	1 – 16
Timer base	cccc	K	0 – 99.99 seconds
Counts per step	dddd	K	0 – 9999
Event	eeee	X, Y, C, S, T, ST, GX, GY, CT, SP	see memory map
Discrete Outputs	Ffff	X, Y, C, GX, GY	
Output Mask	Ggggg	V	

Chapter 6: Drum Instruction Programming

Drum instructions use four counters in the CPU. The ladder program can read the counter values for the drum's status. The ladder program may write a new preset step number to CTA(n+2) at any time. However, the other counters are for monitoring purposes only.

Counter Number	Ranges of (n)	Function	Counter Bit Function
CTA(n)	0 – 174	Counts in step	CT(n) = Drum Complete
CTA(n+1)	1 – 175	Timer value	CT(n+1) = (not used)
CTA(n+2)	2 –176	Preset Step	CT(n+2) = (not used)
CTA(n+3)	3 –177	Current Step	CT(n+1) = (not used)

The following ladder program shows the MDRMD instruction in a typical ladder program, as shown by *DirectSOFT*. Steps 1 through 11 are used, and all 16 output points are used. The output mask word is at V2000. The final drum outputs are shown above the mask word as individual bits. The data bits in V2000 are logically ANDed with the output pattern of the current step in the drum. If you want all drum outputs to be off after powerup, write zeros to V2000 on the first scan. Ladder logic may update the output mask at any time to enable or disable the drum outputs. The preset step is step 1. The timebase runs at $(K10 \times 0.01)=0.1$ second per count. Therefore, the duration of step 1 is $(5 \times 0.1) = 0.5$ seconds. Note that step 1 is time-based only (event is left blank). In the last rung, the Drum Complete bit (CT10) turns on output Y0 upon completion of the last step (step 10). A drum reset also resets CT10.

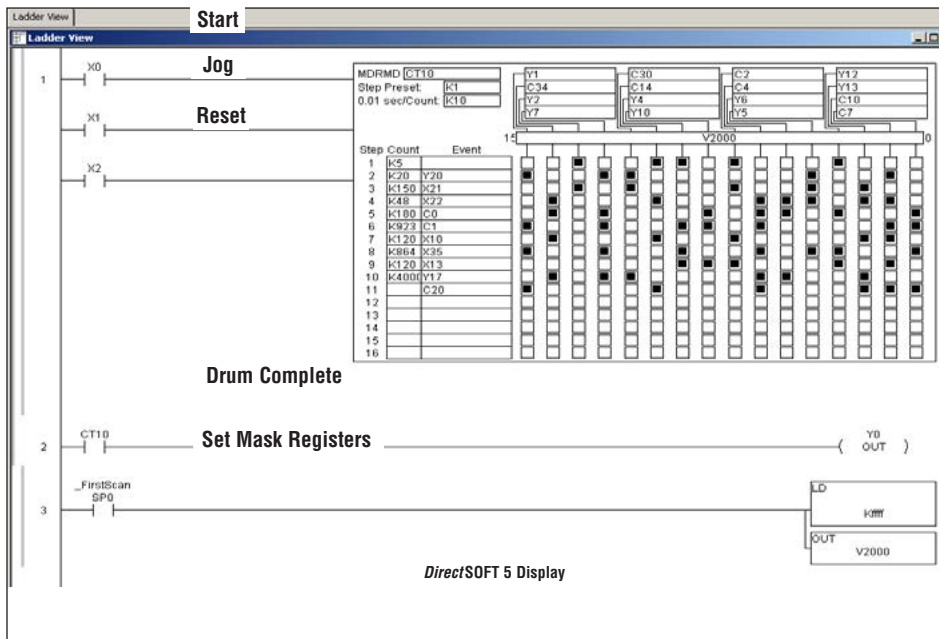

NOTE: The ladder program must load constants in V2000 through V2012 to cover all mask registers for the eleven steps used in this drum.

Masked Event Drum with Word Output (MDRMW)

The Masked Event Drum with Word Output features outputs organized as bits of a single word, rather than discrete points. It operates according to the general principles of drum operation covered in the beginning of this section. Below is the instruction in chart form as displayed by *DirectSOFT*.

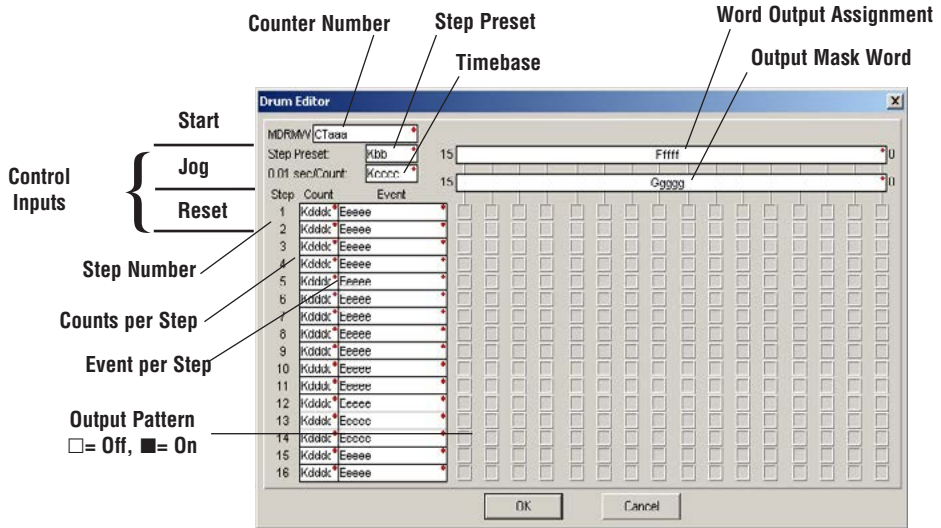

The Masked Event Drum with Word Output features sixteen steps and sixteen outputs. Drum outputs are logically ANDed bit-by-bit with an output mask word for each step. The Ggggg field specifies the beginning location of the 16 mask words, creating the final output (Fffff field). Step transitions occur on timed and/or event basis. The jog input also advances the step on each off-to-on transition. Time is specified in counts per step, and events are specified as discrete contacts. Unused steps and events can be left blank (this is the default entry).

Whenever the Start input is energized, the drum's timer is enabled. As long as the event is true for the current step, the timer runs during that step. When the step count equals the counts per step, the drum transitions to the next step. This process stops when the last step is complete, or when the Reset input is energized. The drum enters the preset step chosen upon a CPU program-to-run mode transition, and whenever the Reset input is energized.

Drum Parameters	Field	Data Types	Ranges
Counter Number	aaa	-	0 - 174
Preset Step	bb	K	1 - 16
Timer base	cccc	K	0 - 99.99 seconds
Counts per step	dddd	K	0 - 9999
Event	eeee	X, Y, C, S, T, ST, GX, GY, SP	see memory map
Word Output	Fffff	V	see memory map
Output Mask	Ggggg	V	see memory map

Chapter 6: Drum Instruction Programming

Drum instructions use four counters in the CPU. The ladder program can read the counter values for the drum's status. The ladder program may write a new preset step number to CTA(n+2) at any time. However, the other counters are for monitoring purposes only.

Counter Number	Ranges of (n)	Function	Counter Bit Function
CTA(n)	0 – 174	Counts in step	CT(n) = Drum Complete
CTA(n+1)	1 – 175	Timer value	CT(n+1) = (not used)
CTA(n+2)	2 –176	Preset Step	CT(n+2) = (not used)
CTA(n+3)	3 –177	Current Step	CT(n+1) = (not used)

The following ladder program shows the MDRMD instruction in a typical ladder program, as shown by *DirectSOFT*. Steps 1 through 11 are used, and all sixteen output points are used. The output mask word is at V2000. The final drum outputs are shown above the mask word as a word at V2001. The data bits in V2000 are logically ANDed with the output pattern of the current step in the drum, generating the contents of V2001. If you want all drum outputs to be off after powerup, write zeros to V2000 on the first scan. Ladder logic may update the output mask at any time to enable or disable the drum outputs. The preset step is step 1. The timebase runs at (K50 x 0.01)=0.5 seconds per count. Therefore, the duration of step 1 is (5 x 0.5) = 2.5 seconds. Note that step 1 is time-based only (event is left blank). In the last rung, the Drum Complete bit (CT14) steps on output Y0 upon completion of the last step (step 10). A drum reset also resets CT14.

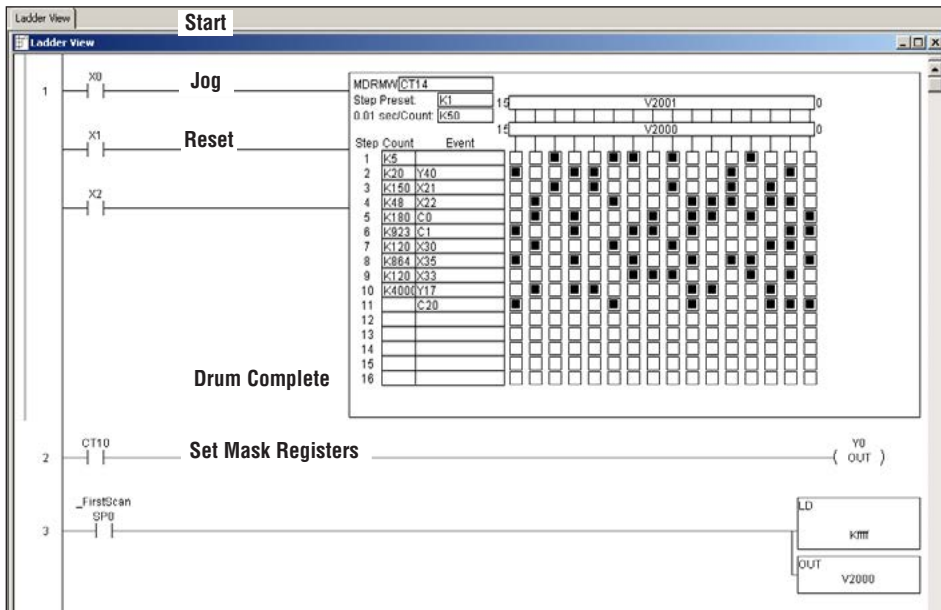

NOTE: The ladder program must load constants in V2000 through V2012 to cover all mask registers for the eleven steps used in this drum.